

INSTRUCTION MANUAL



Measurement of airflow resistance

nor1517A

Ni Norsonic

Nor1517A – User Guide

Im1517_1Ed2R1En – December 2012 Edition

This manual refers to instruments with serial number 23100 and upwards.

Norsonic is a registered trademark of Norsonic AS. Every effort has been made to supply complete and accurate information. However, Norsonic AS assumes no responsibility for the use of – or for the consequential damage resulting from the use of – this information and/or the instrumentation described herein. Furthermore, Norsonic AS assumes no responsibility for any infringement of the intellectual property rights of third parties, wherever applicable, which could result from such use. Norsonic AS reserves the right to amend any of the information given in this manual in order to take account of new developments.

If you wish to communicate with us, please feel welcome. Our address is:

Norsonic AS, P.O. Box 24, N-3421 Lierskogen Norway,

Find us on the web: www.norsonic.com

Tel: +47 3285 8900

Fax: +47 3285 2208

E-mail: info@norsonic.com

Copyright © Norsonic AS 2010

All rights reserved

Introduction

The quantity airflow resistance is one of the most important parameters for the description of porous materials with strong links to its acoustic properties. A low value for the airflow resistance indicates little resistance for air streaming through the material and a high value indicates that the material is closer to air-tight.

This user guide describes operation of the measurement apparatus Nor1517A inclusive the operation of the sound level meter Nor140 used for the measurement. Reference is made to the instrument manual for this instrument for a more detailed description.

A technical section describes the principles for measurement of airflow resistance in general.

Nor1517A measures the specific airflow resistance – and related quantities – by the applying the alternating airflow method (Method B) according to ISO 9053: *Acoustics – Materials for acoustical applications – Determinations of airflow resistance*.

The specimen to be tested is placed so it closes the open end of a vessel with known volume and diameter. The volume of the vessel is altered by a piston moving back and forth in a sinusoidal motion. The volume modulation leads to a pressure modulation counteracted by the air flowing through the specimen. The size of the pressure modulation is directly related to the airflow resistivity and is sensed by the microphone and measured by the sound level meter.

Assembling

Nor1517A

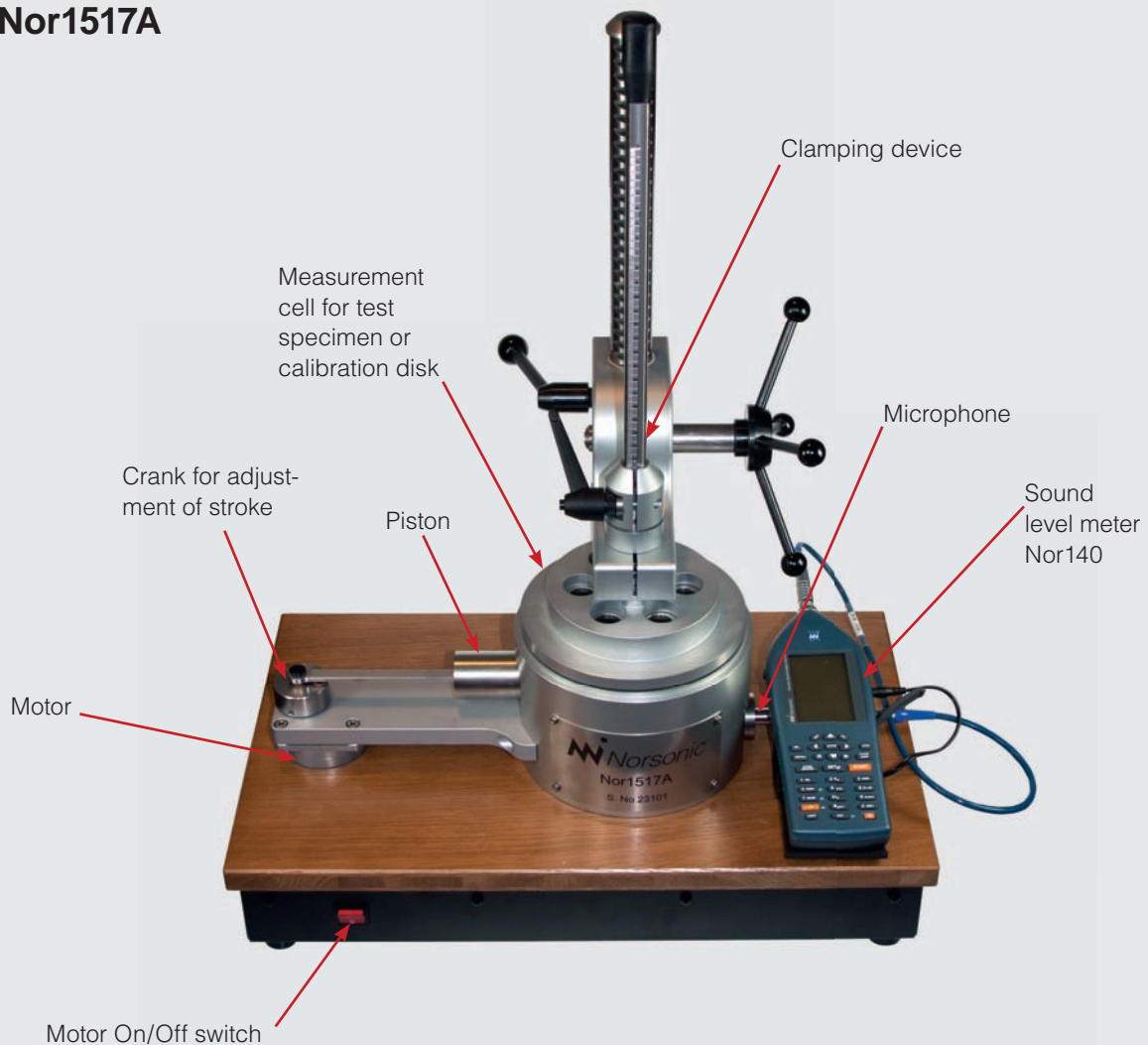

Mounting the upper part

As delivered, the upper part of the device is not mounted. Put the rod in the mounting hole, align the upper and lower part and tighten securely the three mounting screws with the supplied 6 mm hexagon key.



Connect the microphone preamplifier with the supplied microphone cable.

Mount the DC-power cable on the right side of the sound level meter marked "DC 11-16 volt". Place the sound level meter Nor 140 in the stand for the instrument.

Connect the power cord to the mains terminal on the back-side of the test device. The mains switch is adjacent to the mains terminal.

Start/Stop motor

The switch for start and stop of the motor is placed on the lower front. A valve for the ventilation opening of the test vessel is automatically closed when the motor is started.

Connecting the sound level meter

The microphone of the sound level meter shall be mounted in the wall of the test-vessel. A sealing device as shown in the picture below shall be mounted between the microphone and the microphone preamplifier. The sealing device will make an airtight connection between the microphone and the preamplifier and will in addition ensure that the static air-pressure in the vessel also reaches the inside of the microphone through the venting hole for the microphone. Put the assembled microphone in the mounting hole as shown in the picture below. Push the microphone as far as allowed and fasten the preamplifier in the clip.



tion between the microphone and the preamplifier and will in addition ensure that the static air-pressure in the vessel also reaches the inside of the microphone through the venting hole for the microphone. Put the assembled microphone in the mounting hole as shown in the picture below. Push the microphone as far as allowed and fasten the preamplifier in the clip.

Set-up and Calibration

The dimensions of the test vessel, the piston and the length of the stroke are all parameters fixed in the manufacturing process. If the test vessel is closed by an airtight disc, the modulation of the pressure caused by the movement of the piston may be calculated. The operation is similar to how the pistonphone – a sound calibrator for calibration of microphones – works.

The measurement system may therefore be calibrated by setting the sensitivity so a specified value is displayed when the system is operated with the airtight disk. The disk supplied with the system is therefore called a calibration disk.

Operating the sound level meter Nor140

The front panel of sound level meter Nor140 is shown on the next page. The instrument may be powered by the internal batteries or from the mains adapter included in Nor1517A.

This description only covers the functions needed for using the instrument in connection with Nor1517A. Please refer to the instruction manual for the instrument for more information.

Switch on the instrument by pressing **ⓘ**.

After start up of the instrument, the following display is shown.

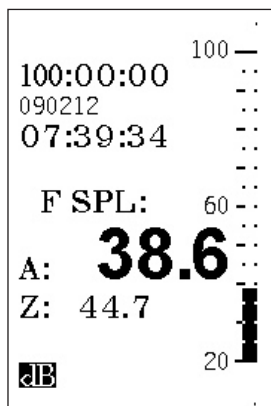

The 2 Hz band to be used is outside the normal frequency range for the sound level meter. The frequency range may be extended in the SETUP menu.

Press the **SETUP** button:



Note! When the normal microphone Nor1225 or Nor1227 is used, the calibration has to be done with the stroke set to 2,8 mm (amplitude 1,4 mm). The high sound level generated may otherwise overload the microphone!

SETUP:

1: Instrument menu
2: Meas. duration

1: Frequency mode

Use the buttons scroll buttons **▼▲** and the buttons **DEC** and **INC** to obtain the following selection (1/3-octave, wide):

Freq mode:

Mode: On
Bandw.: **1/3w**

Return to the level display by pressing **ENTER** repeatedly. Move the cursor to the 2 Hz band.

Press the button **2 f↔t** to display level versus frequency as shown below. The button may be used to toggle between level versus time and level versus frequency. For this application the level in the 2 Hz band is used since 2 Hz corresponds to the frequency of the oscillating piston.

Adjusting the instrument sensitivity

Switch off the motor and select 2,8 mm stroke.



Note! Always switch off the motor when the specimen for test or the calibration disk is mounted.

A valve will open when the motor is not running and thus prevent build-up of excess pressure which may harm the microphone! Mount the calibration disc firmly so it will close the vessel and be airtight.

Sound level meter Nor140

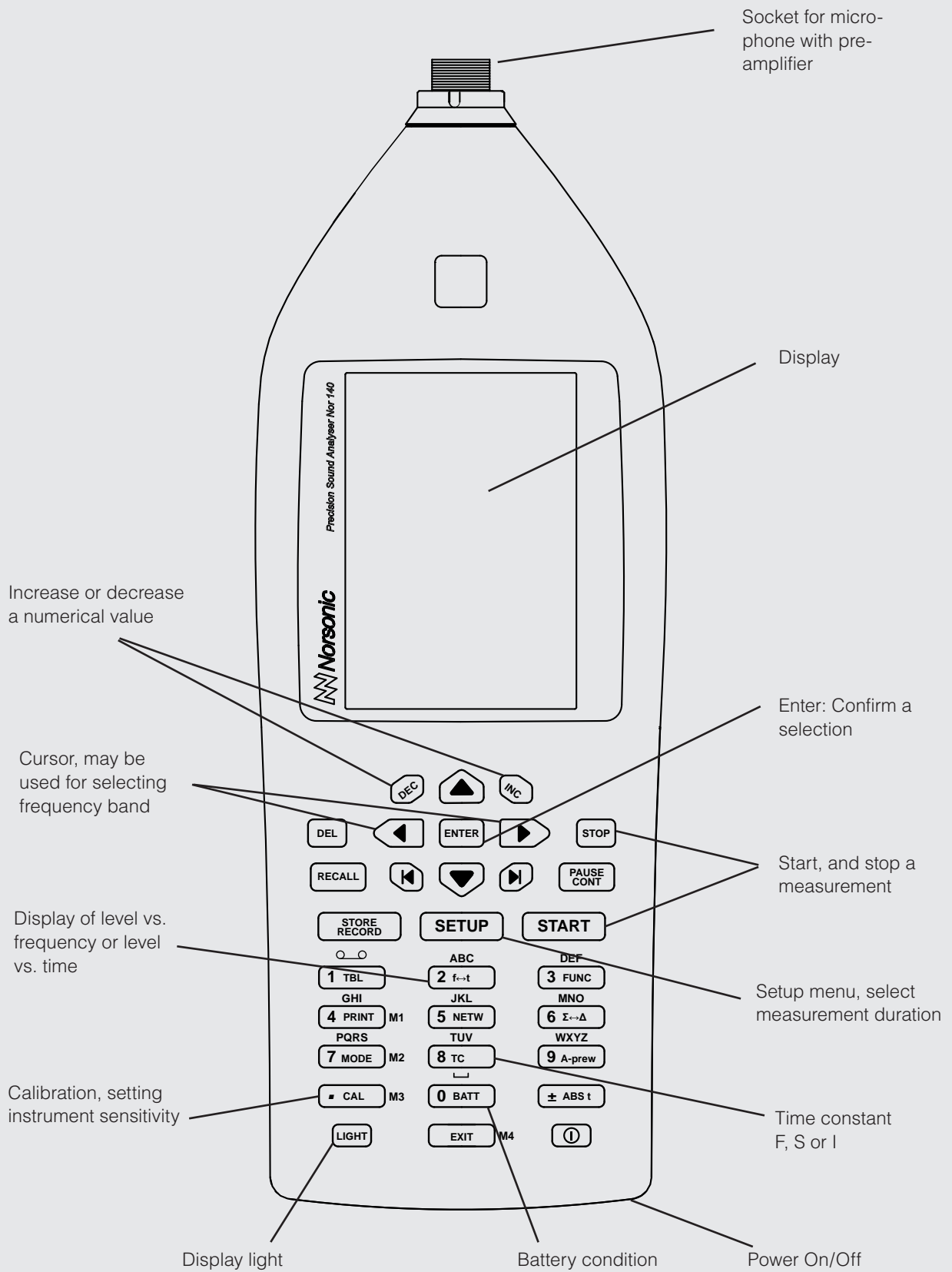

Turn the crank so the piston is in the centre position. Start the motor and read the displayed level in dB. For the normal air pressure (101,325 kPa), the sensitivity has to be adjusted so the displayed level for the 2 Hz band is 174,3 dB. (Note: This level is not relative to 20 mPa.) See table at the end of Technical description for applicable levels for other air pressures. Calculate the difference between the displayed value and the aim. This offset value is later used for adjusting the sensitivity.

Press the calibration button **CAL**. The current sensitivity (Sens. :) will be displayed:

Use INC or DEC to modify the sensitivity or....

...enter the sensitivity as a numerical value

Calculate the new sensitivity by adding the offset to the current sensitivity and enter the new value. For microphone Nor1225 and Nor1227 (50 mV/Pa), the sensitivity shall be about -74 dB.

Press the button **ENTER** two times so the level versus frequency is displayed. The displayed value for the 2 Hz band shall now be 174,3 dB or the value according to the current air pressure. Repeat the calibration procedure if necessary. The display shall therefore be as shown:



It is recommended to turn the crank so the piston is in the centre position before you start the motor. This will ensure that the air pressure in the test vessel is equal to the outside pressure. This is especially important during calibration where the calibration disc makes the test vessel to an airtight enclosure.

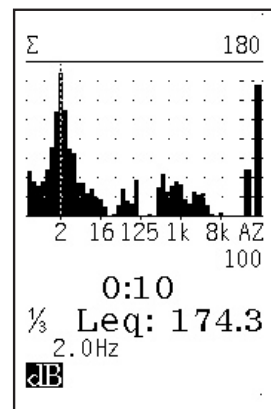

Set the instrument to display linear units

The logarithmic decibel scale is not convenient for reading airflow resistance values. The instrument is therefore set to display the results in linear units. In the instrument menu, this is called engineering units – **EU**. For our application the unit is Pa·s/m.

Press **SETUP** and press 1 for selecting the instrument menu.

SETUP:

1: Instrument menu

2: Meas. duration

4: Frequency mode

#

Press **9** in the Instrument menu for selecting Misc.par.

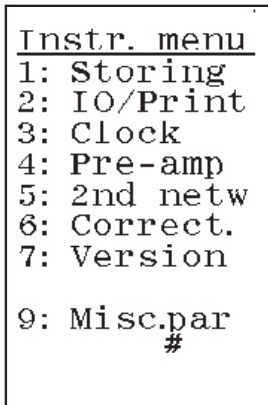

Select 6: Units and scroll ▼▲ to highlight EU in the next menu.

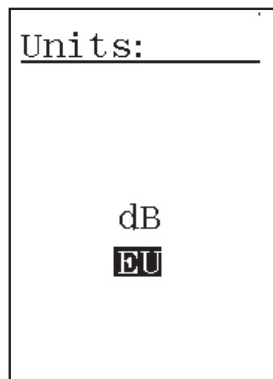
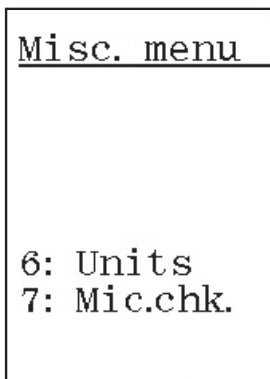

Press the button **ENTER** repeatedly to obtain the level versus frequency display – this time with the values displayed in Pa·s/m. The value should be about 10300 Pa·s/m when the calibration disk is used with the stroke 2.8 mm. The value is displayed as 10.3 k where *k* means 1000 or kilo.

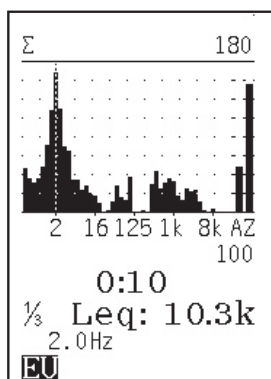

Mounting the specimen to be tested

It is important that the airflow in the material to be tested have a well defined area for the flow and no leakage at the boundary. Thin materials up to a few mm may just be clamped between the test vessel and the lid. Use the upper and lower grid to clamp the material so it will not move up and down by the alternating airflow. Such a movement will reduce the reading.

Thicker samples should be mounted in a fixture with a circular opening to prevent the air flowing to the sides or through a larger area than the opening of the test vessel. The figure below shows a correct mounting with a flow normal to the test surface and no leaks at the boundary.

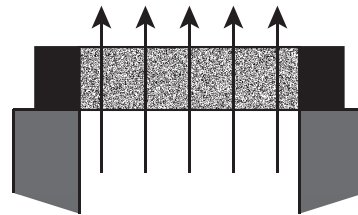

The next figure below shows an incorrect mounting which will lead to a too low reading of the resistance

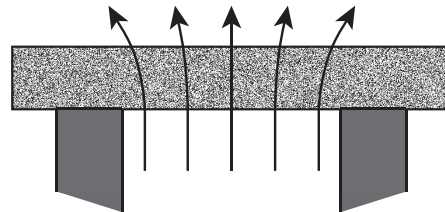

Switch off the motor before the calibration disk is removed!



Thin specimen may be clamped between the test-vessel and the top.



The sample holder Nor1517A/03 may be used for testing of materials like rock wool.

Measurement

For measurements the stroke shall be set to 28 mm (amplitude 14 mm). The calibration procedure is adapted to this selection.

Switch off the motor before the test specimen is mounted or removed in order to protect the sensitive microphone!

Mount the specimen to be tested. Use an adapter with the same diameter as the test vessel (diameter 100 mm) so the air will flow through the specimen and not through the side of it. Norsonic may supply different mounting devices dependent on the thickness of the specimen.

Select a suitable measurement time, e.g. 10 s. The measurement time should always be a whole number of periods of the 2 Hz excitation signal.

Start the motor and start a measurement. The value for the 2 Hz band displays the specific airflow resistance in Pa·s/m. Read the L_{eq} -value!

Airflow resistance, specific airflow resistance and airflow resistivity

This description has been made for the direct reading of specific airflow resistance, R_s , that is the observed resistance normalised to an area for the specimen of 1 m². The non-normalized value, airflow resistance R , may be computed by division with the area for testing A . The nominal value for the area corresponds to the test surface with diameter 100 mm.

$$A = 7,854 \cdot 10^{-3} \text{ m}^2$$

The unit for R will be Pa·s/m³.

For homogeneous materials the airflow resistance will often be proportional with the thickness d . The airflow resistivity, which is the specific airflow resistance per unit length is given by:

$$r = \frac{R_s}{d}$$

The unit for airflow resistivity is Pa·s/m².

Background noise

The lower limit for the measurement will mainly be determined by the background noise in the room for the measurement. Always check the indication when the vessel is completely open. The lower limit will be from about three times above this indication (10dB).

Note that the ventilation system in a building often creates very large levels of low-frequency sound pressure. For measurement of materials with low airflow resistivity, the ventilation system often has to be stopped or the whole apparatus has to be placed in an airtight enclosure. Remote operation of Nor140 may then be required.

Technical description

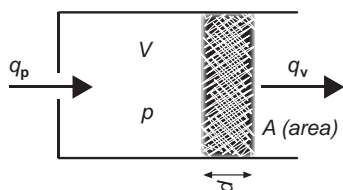

Measurement principle

When air flows through a specimen of a porous material the air pressure will increase in front of the flow. The ratio between the pressure increase and the flow is called airflow resistance, symbol R . The airflow resistance can be measured by the use of a steady airflow (DC) or through the use of an alternating pressure (AC). Both principles are described in the international standard ISO9053.

The figure below shows a sketch of how the Airflow resistance analyser Nor1517 is constructed.

An alternating airflow through the test specimen is gen-

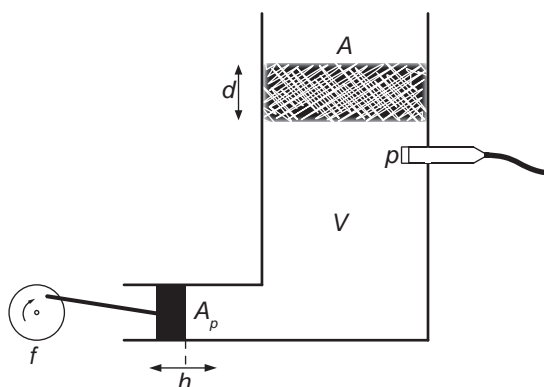

erated by a piston moving back and forth in a sinusoidal motion with a frequency, f , and a peak to peak amplitude h . The area for the piston is A_p and the area for the specimen is A . When the piston is in the centre position, the effective volume between the piston and the test specimen is V .

The pressure in front of the test specimen is measured with a microphone. The microphone will measure the pressure difference, p , between the inside and the outside of the vessel.

It can be shown that the relation between the pressure in the vessel and the specific airflow resistance is given by:

$$R_s = \frac{A \cdot p}{2 \cdot \pi \cdot f \cdot \frac{A_p h}{2\sqrt{2}} \sqrt{1 - \left(\frac{V \cdot p}{P_a \cdot \gamma \cdot \frac{A_p h}{2\sqrt{2}}} \right)^2}}$$

where

A : area of test specimen, nominal value $7,854 \cdot 10^{-3} \text{ m}^2$;

d : thickness of test specimen [m]

p : sound pressure observed by the microphone [Pa];

f : frequency of excitation, nominal value 2 Hz;

A_p : area of the piston, nominal value $3,142 \cdot 10^{-4} \text{ m}^2$;

h : peak-to-peak amplitude of the piston movement, nominal value $28 \cdot 10^{-3} \text{ m}$ or $2,8 \cdot 10^{-3} \text{ m}$ dependent on setting;

V : volume of the vessel, nominal value $8,5 \cdot 10^{-4} \text{ m}^3$

P_a : atmospheric air pressure, nominal value 101325 Pa;

γ : ratio of specific heat C_p/C_v for air, nominal value 1,4.

When the sound pressure is given as the usual sound pressure level, L , in dB relative to the reference $p_0 = 20 \mu\text{Pa}$, the formula above will be:

$$R_s = \frac{A \cdot p_0 \cdot 10^{L/20}}{2 \cdot \pi \cdot f \cdot \frac{A_p h}{2\sqrt{2}} \sqrt{1 - \left(\frac{V \cdot p_0 \cdot 10^{L/20}}{P_a \cdot \gamma \cdot \frac{A_p h}{2\sqrt{2}}} \right)^2}}$$

The equation is based on adiabatic compression. When the vessel is closed by an airtight calibration disc the resistance will be infinite and the corresponding sound pressure level L_c will be given by:

$$L_c = 20 \lg \left[\frac{P_a \cdot \gamma \cdot \frac{A_p \cdot h}{2\sqrt{2} \cdot V}}{p_0} \right]$$

The nominal value for L_c is 148,3 dB for $h = 28 \text{ mm}$ and 128,3 dB for $h = 2,8 \text{ mm}$ when the air pressure is equal to the reference pressure 101,325 kPa.

For resistances where the observed level is significantly below L_c , the relation between the resistance and the sound pressure will be close to linear and equation above can be simplified:

$$R_{s,lin} = \frac{A \cdot p_0 \cdot 10^{L/20}}{2 \cdot \pi \cdot f \cdot \frac{A_p h}{2\sqrt{2}}}$$

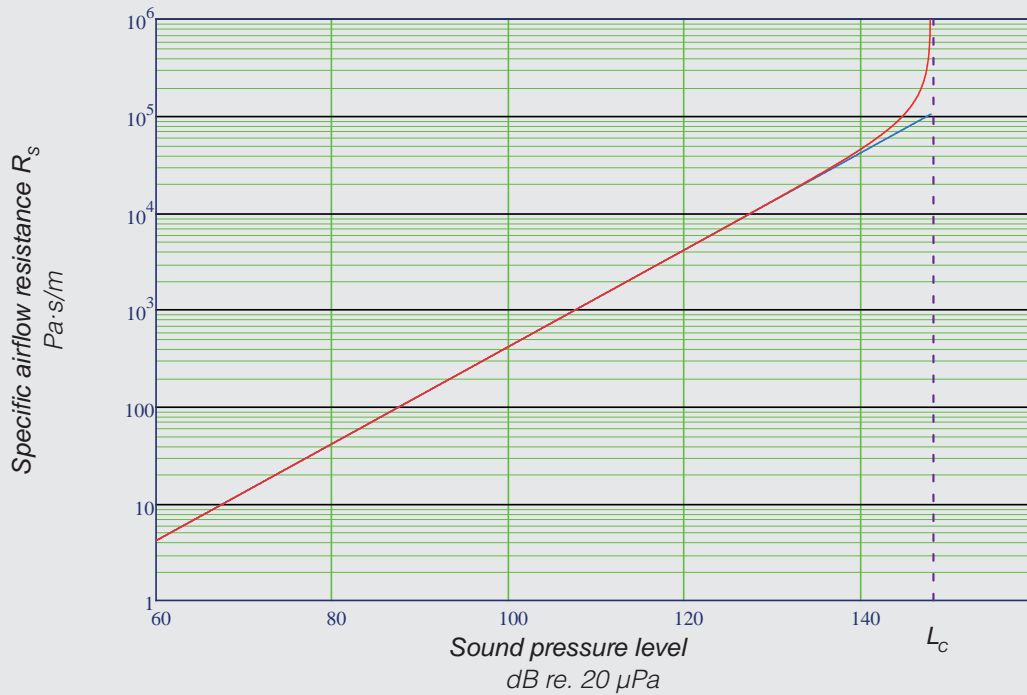

The figure shows the relation between the sound pressure level and specific airflow resistance for a stroke of 28 mm. The linear approximation is within 5% of the correct value when R_s is less than 30000 Pa·s/m. Above this value, the full equation has to be applied.

When the level L_c is put into this formula, the linear relationship may be calibrated by adjusting the sound level meter by the use of the airtight calibration disc.

$$R_{S.lin}(L_c) = R_{Sc} = \frac{A \cdot P_a \cdot \gamma}{2\pi \cdot f \cdot V}$$

The nominal value of R_{Sc} is 104300 Pa·s/m but the value will directly depend on the atmospheric air pressure.

The figure above shows the relation between the observed sound pressure level and the specific airflow resistance. The linear relationship is also shown.

Airflow resistance and level

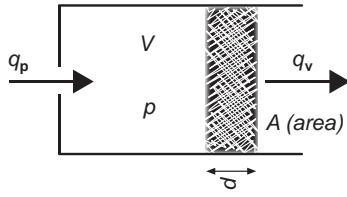

The figure above shows a model of the test unit. An airflow q_p generated by the movement of the piston enters the test vessel with volume V . The test specimen with resistance R is placed in the opposite end of the test vessel. The airflow through the test specimen is q_v .

In an infinitesimal short time, dt , the difference between the airflow in and out of the vessel will act as a change in volume, dV , of the enclosed air.

$$dV = (q_v - q_p)dt$$

A volume change will create an approximately adiabatic compression of the air where the small increase in the pressure p will be:

$$dp = -\gamma \cdot P_a \cdot \frac{dV}{V}$$

The airflow through the test specimen, q_v , will be proportional to the pressure, p , and inversely proportional to the airflow resistance, R :

$$q_v = \frac{p}{R}$$

The root-mean-square value of airflow generated by the sinusoidal motion of the piston is:

$$q_p = \frac{A_p \cdot h \cdot \pi \cdot f}{\sqrt{2}}$$

Combining the equations above gives the following differential equation:

$$\frac{dp}{dt} + p \frac{\gamma \cdot P_a}{V \cdot R} = \gamma \frac{P_a}{V} q_p$$

Solving this differential equation and using the actual value for q_p , gives the following magnitude for the rms-value of the pressure:

$$p = \frac{R_s / A}{\sqrt{1 + \left[2 \cdot \pi \cdot f \frac{V \cdot R_s}{\gamma \cdot P_a \cdot A} \right]^2}} \cdot \frac{A_p \cdot h \cdot \pi \cdot f}{2 \cdot \sqrt{2}}$$

This equation may be solved for the specific airflow resistance, R_s , as the dependent variable:

$$R_s = \frac{A \cdot p}{2 \cdot \pi \cdot f \cdot \frac{A_p \cdot h}{2 \sqrt{2}} \sqrt{1 - \left(\frac{V \cdot p}{P_a \cdot \gamma \cdot \frac{A_p \cdot h}{2 \sqrt{2}}} \right)^2}}$$

Calibration offset

When the instrument is calibrated as described, the reading in dB will have an offset compared to the normal sound pressure level in dB relative to the normal reference value 20 μ Pa. The reason for the offset is to align the reading with the value of the specific airflow resistance and not the sound pressure in Pascal. The offset is given by:

$$\Delta L_{adj} = 20 \log \left(\frac{A \sqrt{2}}{\pi \cdot f \cdot A_p \cdot h} \frac{m}{s} \right) = 46,06 \text{ dB}$$

Heat conduction

In the description above it is assumed that the compression of the air is made adiabatically. Thus the temperature of the air will be modulated by the same frequency as the change of volume by the piston. Air in the vicinity of the walls of the vessel will however, not change temperature due to the large heat capacity of the walls compared to heat capacity for the air. The heat conduction will act as an increase in the volume of the vessel. The formulas from *IEC 60941-2: Measurement microphones – Part 2: Primary method for pressure calibration of laboratory standard microphones by the reciprocity technique*, indicates that the increase in volume will be less than 2%. The change in volume will mainly affect the calibration of the microphone by the closed vessel method. The calculated influence corresponds to a decrease in the calibration level of 0,16 dB.

Environmental conditions

The measurement of specific airflow resistance as describes above determines the resistance at the prevailing environmental condition. Since the material to be tested can change performance in a non-regular manner as a function of the environmental condition such as temperature, humidity and air-pressure, no general statement of the resistance at other environmental conditions can be made.

However, the sound pressure level generated during calibration with the calibration disc will directly be affected by the atmospheric pressure. The adjacent table shows how the atmospheric pressure will affect the reading during calibration. For proper calibration, adjust the reading according to the current air pressure.

Values to be obtained during calibration with the stroke set to 2,8 mm		
Air pressure <i>kPa</i>	Calibration level <i>dB</i>	Calibration value <i>Pa·s/m</i>
105	174,6	10758
104	174,5	10656
103	174,4	10553
102	174,4	10451
101,325	174,3	10382
101	174,3	10348
100	174,2	10246
99	174,1	10143
98	174,0	10041
97	173,9	9939
96	173,8	9836
95	173,7	9734
94	173,7	9631
93	173,6	9529
92	173,5	9426
91	173,4	9324
90	173,3	9221
89	173,2	9119
88	173,1	9016
87	173,0	8914
86	172,9	8811
85	172,8	8709
84	172,7	8607
83	172,6	8504
82	172,5	8402
81	172,4	8299
80	172,3	8197
79	172,1	8094
78	172,0	7992
77	171,9	7889
76	171,8	7787
75	171,7	7684
74	171,6	7582
73	171,5	7480
72	171,3	7377
71	171,2	7275
70	171,1	7172
69	171,0	7070
68	170,8	6967
67	170,7	6865
66	170,6	6762
65	170,4	6660

Note that levels in the table are for adjusting the sensitivity of the instrument so the display will show the specific airflow resistance. The sound pressure in the test vessel during calibration as expressed in level re. 20 μ Pa is 46,1 dB lower than the values indicated.

Specifications

Function: Measure the specific airflow resistance in Pa s m^{-1} according to ISO 9053 (1991): Acoustics – Materials for acoustical applications – Determination of airflow resistance. Related quantities as airflow resistance and airflow resistivity may also be measured.

Measurement range: 10 Pa s m^{-1} to 30 000 Pa s m^{-1} , up to 200 000 Pa s m^{-1} when correcting for non-linearities.

Airflow speed: 0,5 mm/s and 5 mm/s (r.m.s.) selected by the stroke 2,8 mm or 28 mm

Diameter of test area: 100 mm

Overall dimension (W×D×H): 590 mm × 290 mm × 640 mm

Power supply: 230 V/50 Hz (or 110 V/60 Hz – option US)

Weight: 19 kg

Accessories included

- Calibration disc
- Sample holder 1517A/03
- Sound level meter Nor140 with microphone, sealing device and 1/3 octave filters
- Mains cable
- Hex key 6 mm
- Instruction manual

Accessories

Sample holder Nor1517A/02

Norsonic may deliver mounting devices for test materials.

Ask the factory for special needs

Accessories

Sample holder Nor1517A/02

The sample holder Nor1517A/02 is made for measurement of airflow resistance of materials with thickness in the range 0 mm – 40 mm. The internal diameter is 120 mm and therefore larger than the active area for the resistance measurement which has a diameter of 100 mm

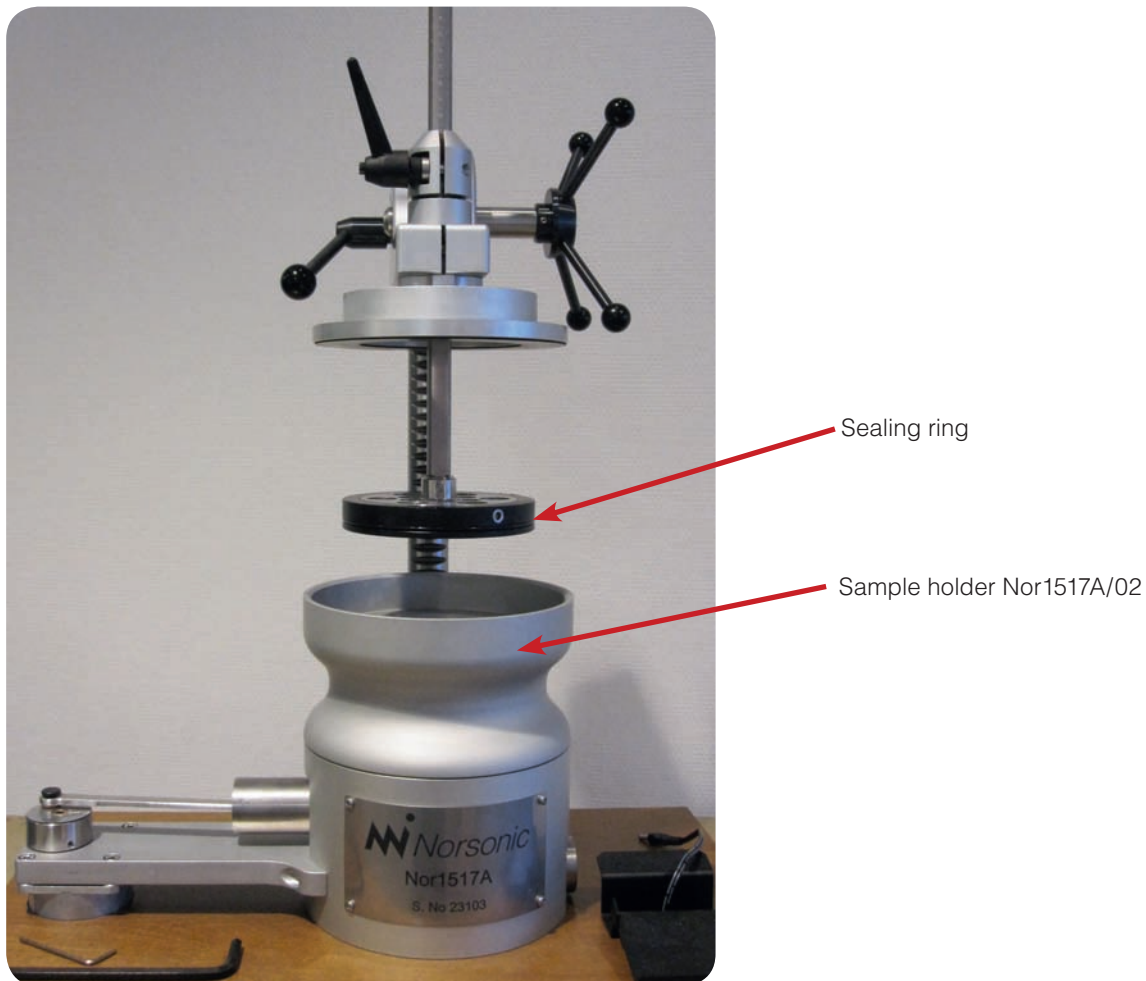

The sample is clamped between the top of the vessel and a sealing ring. See figure below. This makes the test less sensitive to air-leakage along the edge of the sample.

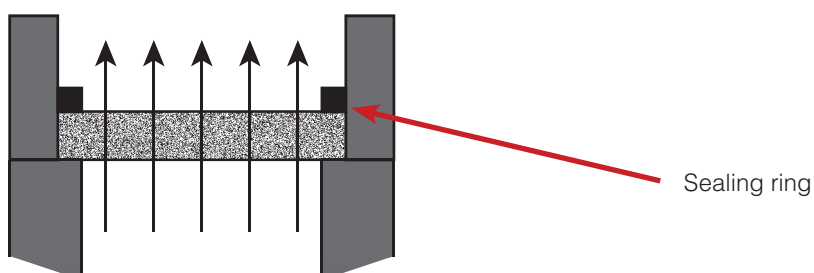

The sealing ring is mounted on the circumference of the upper sample clamp. The sealing device is fastened by three screws as shown on the figure below. Rotate the sealing ring so the screws are entering the holes in the upper sample clamping device. Ensure that the heads of the screws are below the surface of the ring without using excessive force. See the figures below for information.

Upper sample clamp with mouting hole

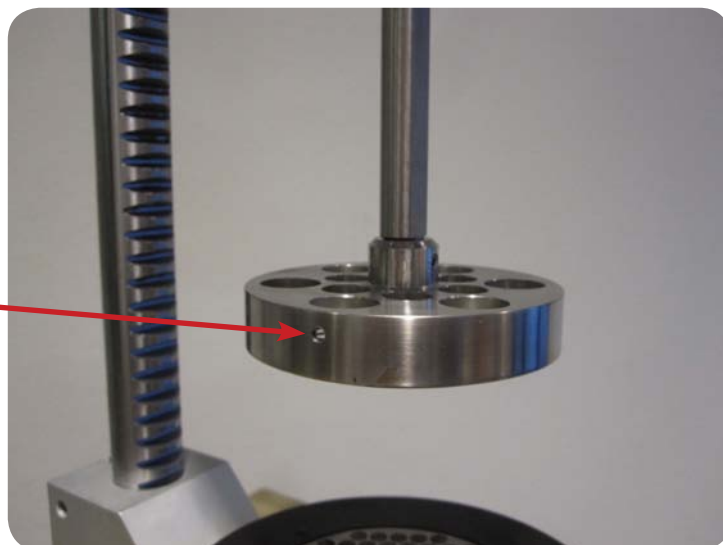

Ensure that the holes and the screws are in line.

The picture shows the sealing ring mounted on the upper sample clamping device.

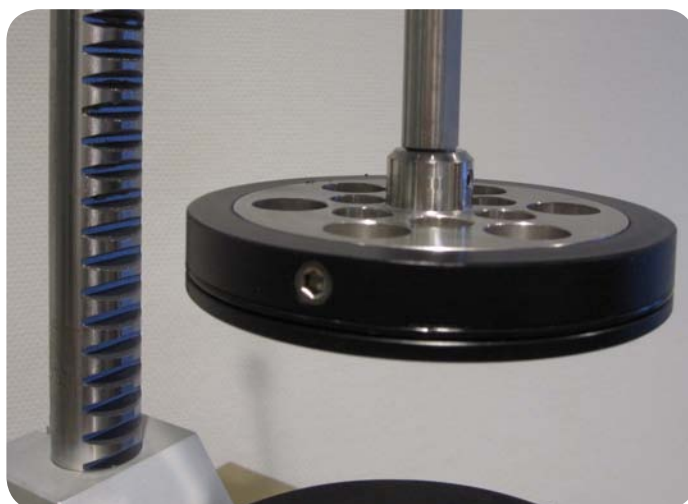



The sample is mounted inside the sample holder Nor1517A/02 and the upper sample clamping device with the sealing ring.

Accessories included:

Hex key 4 mm

Declaration of Conformity

We, Norsonic AS, Gunnersbråtan 2, Tranby, Norway,
declare under our sole responsibility that the product:

Measurement of airflow resistance Nor1517A

to which this declaration relates, is in conformity with the following standards or
other normative documents:

Safety: EN61010-1: Februar 2001 for portable equipment
and pollution category 2.

EMC: EN 6100-6-3; 2001
EN 6100-6-2; 2005

following the provisions of the EU Machine Directive 98/37/EC of 22. June 1998.
Configuration for test: Connected to public power supply.

This product has been manufactured in compliance with the provisions of the relevant internal Norsonic produc-
tion standards. All our products are tested individually before they leave the factory.

This Declaration of Conformity does not affect our warranty obligations.

Tranby, November 2011



Dagfinn Jahr
Quality Manager

The declaration of conformity is given according to EN 45014 and ISO/IEC Guide 22.
Norsonic AS, P.O. Box 24, N-3420 Lierskogen, Norway



P.O. Box 24
N-3421 Lierskogen
Norway
Tel: +47 3285 8900
Fax: +47 3285 2208
info@norsonic.com
www.norsonic.com

Norsonic AS supplies a complete range of instrumentation for acoustics – from sound calibrators, microphones and preamplifiers; via small handheld sound level meters to advanced, yet portable, real time analysers, but also spectrum shapers, building acoustics analysers and complete community, industry and airport noise monitoring systems. Contact your local representative or the factory for information on our complete range of instrumentation.